



ALCATEL GO FLIP V USER GUIDE

Note: This is a user manual for the Alcatel GO FLIP V (4051S)

Table of Contents

| | |
|------------------------------------|-----------|
| Safety and use | 1 |
| Radio waves | 5 |
| License | 9 |
| General information | 11 |
| 1 Your mobile | 12 |
| 1.1 Keys and connectors | 12 |
| 1.2 Getting started | 15 |
| 1.3 Home screen | 18 |
| 1.4 App list..... | 19 |
| 1.5 Inputting text..... | 19 |
| 2 Calls | 21 |
| 2.1 Making a call..... | 21 |
| 2.2 Answer or decline a call | 22 |
| 2.3 Calling your voicemail | 22 |
| 3 Contacts | 23 |
| 3.1 View your contacts..... | 23 |
| 3.2 Adding a contact | 23 |
| 3.3 Deleting a contact..... | 24 |
| 3.4 Editing your contacts | 24 |
| 3.5 Select contacts | 25 |

| | | |
|----------|---------------------------------|-----------|
| 3.6 | Sharing your contacts | 25 |
| 3.7 | Speed Dial..... | 25 |
| 3.8 | Available options..... | 26 |
| 4 | Messages | 27 |
| 4.1 | Write message..... | 27 |
| 4.2 | Send a multimedia message | 28 |
| 4.3 | Settings | 28 |
| 5 | Email..... | 30 |
| 6 | Media center..... | 31 |
| 7 | Browser..... | 32 |
| 8 | Tools..... | 33 |
| 8.1 | Recorder | 33 |
| 8.2 | Calendar | 33 |
| 8.3 | Clock | 34 |
| 8.4 | Note..... | 36 |
| 8.5 | Calculator | 37 |
| 8.6 | File manager | 37 |
| 8.7 | Camera..... | 38 |
| 9 | Settings..... | 40 |
| 9.1 | My Verizon | 40 |
| 9.2 | Wireless & Networks..... | 40 |
| 9.3 | Accessibility | 43 |
| 9.4 | Sound & notifications..... | 44 |
| 9.5 | Display | 45 |
| 9.6 | Phone settings..... | 45 |

| | | |
|-----------|-------------------------------------|-----------|
| 9.7 | Call settings | 47 |
| 9.8 | About phone | 48 |
| 9.9 | Software update | 49 |
| 10 | Accessories | 50 |
| 11 | 1 Year Limited Warranty..... | 51 |
| 12 | Troubleshooting | 54 |
| 13 | Specifications | 58 |



www.sar-tick.com

alcatel

This product meets applicable national SAR limits of 1.6 W/kg. The specific maximum SAR values can be found in **RADIO WAVES** of this user guide.

When carrying the product or using it while worn on your body, either use an approved accessory such as a holster or otherwise maintain a distance of 15mm from the body to ensure compliance with radiofrequency (RF) exposure requirements. Note that the product may be transmitting even if you are not making a phone call.



PROTECT YOUR HEARING

To prevent possible hearing damage, do not listen at high volume levels for long periods. Exercise caution when holding your device near your ear while the loudspeaker is in use.

Safety and use.....

We recommend that you read this chapter carefully before using your phone. The manufacturer disclaims any liability for damage, which may result as a consequence of improper use or use contrary to the instructions contained herein.

TRAFFIC SAFETY

Given that studies show that using a phone while driving a vehicle constitutes a real risk, even when a hands-free kit is used (such as Bluetooth car kit or headset), drivers are recommended to refrain from using their phone when the vehicle is not parked. Check the laws and regulations on the use of wireless phones and their accessories in the areas where you drive. Always obey them. The use of these devices may be prohibited or restricted in certain areas.

CONDITIONS OF USE

- You are advised to switch off the phone from time to time to optimize its performance.
- Remember to abide by local authority rules of mobile phone use on aircrafts.
- Always handle your phone with care and keep it in a clean and dust-free place.
- Do not allow your phone to be exposed to adverse weather or environmental conditions, such as moisture, humidity, rain, infiltration of liquids, dust, sea air, etc. The manufacturer's recommended operating temperature range is 0°C (32°F) to 50°C (122°F). At over 50°C (122°F), the legibility of the phone's display may be temporarily impaired.
- Do not open, dismantle, or attempt to repair your phone yourself.
- Do not drop, throw, or bend your phone.
- Use only batteries, battery chargers, and accessories which are recommended by TCL Communication Ltd. and its affiliates and are compatible with your phone model. TCL Communication Ltd. and its affiliates disclaim any liability for damage caused by the use of other chargers or batteries.
- Your phone should not be disposed of in a municipal waste. Please check local regulations for disposal of electronic products.

- Remember to make backup copies or keep a written record of all important information stored on your phone.
- Some people may suffer epileptic seizures or blackouts when exposed to flashing lights, or when playing video games. These seizures or blackouts may occur even if a person never had a previous seizure or blackout. If you have experienced seizures or blackouts, or if you have a family history of such occurrences, please consult your doctor before playing video games on your phone or enabling a flashing-lights feature on your phone.
- Parents should monitor their children's use of video games or other features that incorporate flashing lights on the phones. All persons should discontinue use and consult a doctor if any of the following symptoms occur: convulsion, eye or muscle twitching, loss of awareness, orientation, or movements.

PRIVACY

Please note that you must respect the laws and regulations in force in your jurisdiction or other jurisdiction(s) where you will use your phone regarding taking photographs and recording sounds with your phone. Pursuant to such laws and regulations, it may be strictly forbidden to take photographs and/or to record the voices of other people or any of their personal attributes, and reproduce or distribute them, as this may be considered to be an invasion of privacy. It is the user's sole responsibility to ensure that prior authorization has been obtained, if necessary, in order to record private or confidential conversations or take a photograph of another person. The manufacturer, the seller or vendor of your phone (including the carrier) disclaim any liability which may result from improper use of the phone.

BATTERY:

For a non-unibody device:

Observe the following precautions:

- Do not attempt to open the battery (due to the risk of toxic fumes and burns).
- Do not puncture, disassemble, or cause a short circuit in a battery.
- Do not burn or dispose of a used battery in household rubbish or store it at temperatures above 60°C (140°F).

Batteries must be disposed of in accordance with locally applicable environmental regulations. Only use the battery for the purpose for which it was designed. Never use damaged batteries or those not recommended by TCL Communication Ltd. and/or its affiliates.



This symbol on your phone, the battery, and the accessories means that these products must be taken to collection points at the end of their life:

- Municipal waste disposal centers with specific bins for these types of equipment.
- Collection bins at points of sale.

They will then be recycled, preventing substances being disposed of in the environment, so that their components can be reused.

In European Union countries:

These collection points are accessible free of charge.

All products with this sign must be brought to these collection points.

In non European Union jurisdictions:

Items of equipment with this symbol are not to be thrown into ordinary bins if your jurisdiction or your region has suitable recycling and collection facilities. Instead they are to be taken to collection points for them to be recycled.

Electronic Recycling

For more information on Electronic Recycling, please Visit Alcatel Electronic Recycling Program website at (USA) <https://us.alcatelmobile.com/accessibility-compliance/electronic-recycling-program/> and (Canada) <https://ca.alcatelmobile.com/accessibility-compliance/electronic-recycling-program/>

Battery Recycling

Alcatel partners with Call2Recycle® to offer a safe and convenient battery recycling program.

For more information on our Battery Recycling Program, please visit the USA and Canada website at <https://us.alcatelmobile.com/accessibility-compliance/battery-recycling/> and <https://ca.alcatelmobile.com/accessibility-compliance/battery-recycling/>

CAUTION: RISK OF EXPLOSION IF BATTERY IS REPLACED BY AN INCORRECT TYPE. DISPOSE OF USED BATTERIES ACCORDING TO THE INSTRUCTIONS.



WARNING Cancer and Reproductive Harm www.P65Warnings.ca.gov

CHARGERS:

Home A.C./ Travel chargers will operate within the temperature range of: 0°C (32°F) to 45°C (113°F).

The chargers designed for your phone meet the standard for safety of information technology equipment and office equipment use. Due to different applicable electrical specifications, a charger you purchased in one jurisdiction may not work in another jurisdiction. They should be used for this purpose only.

Characteristics of power supply (depending on the country):

Travel charger: 100-240V, 50/60Hz, 150mA

Radio waves.....

THIS PHONE MEETS THE GOVERNMENT'S REQUIREMENTS FOR EXPOSURE TO RADIO WAVES.

Your phone is a radio transmitter and receiver. It is designed and manufactured not to exceed the emission limits for exposure to radio frequency (RF) energy. These limits are part of comprehensive guidelines and establish permitted levels of RF energy for the general population. The guidelines are based on standards that were developed by independent scientific organizations through periodic and thorough evaluation of scientific studies. These guidelines include a substantial safety margin designed to ensure the safety of all persons, regardless of age and health.

The exposure standard for phones employs a unit of measurement known as the Specific Absorption Rate, or SAR. The SAR limit set by public authorities such as the Federal Communications Commission of the US Government (FCC), or by Innovation, Science and Economic Development Canada (ISED), is 1.6 W/kg averaged over 1 gram of body tissue. Tests for SAR are conducted using standard operating positions with the phone transmitting at its highest certified power level in all tested frequency bands.

This device is compliant with SAR for general population / uncontrolled exposure limits in ANSI/IEEE C95.1-1992 and had been tested in accordance with the measurement methods and procedures specified in IEEE1528.

The FCC has granted an Equipment Authorization for this model phone with all reported SAR levels evaluated as in compliance with the FCC RF exposure guidelines. SAR information on this model phone is on file with the FCC and can be found under the Display Grant section of www.fcc.gov/oet/ea/fccid after searching on FCC ID:2ACCJN030

Although the SAR is determined at the highest certified power level, the actual SAR level of the phone while operating can be well below the maximum value. This is because the phone is designed to operate at multiple power levels so as to use only the power required to reach the network. In general, the closer you are to a wireless base station antenna, the lower the power output of the phone. Before a phone model is available for sale to the public, compliance with national regulations and standards must be shown.

The highest SAR value for this model phone when tested is 1.08 W/Kg for use at the ear and 1.32 W/Kg for use close to the body.

While there may be differences between the SAR levels of various phones and at various positions, they all meet the government requirement for RF exposure.

For body-worn operation, the phone meets FCC RF exposure guidelines provided that it is used with a non-metallic accessory with the handset at least 15 mm from the body.

Use of other accessories may not ensure compliance with FCC RF exposure guidelines.

Additional information on SAR can be found on the Cellular Telecommunications & Internet Association (CTIA) Web site: <http://www.ctia.org/>

The World Health Organization (WHO) considers that present scientific information does not indicate the need for any special precautions for use of phones. If individuals are concerned, they may choose to limit their own or their children's RF exposure by limiting the length of calls, or using "hands-free" devices to keep phones away from the head and body. Additional WHO information about electromagnetic fields and public health are available on the following website: <http://www.who.int/peh-emf>.

Note: This equipment has been tested and found to comply with the limits for a Class B digital device pursuant to part 15 of the FCC Rules. These limits are designed to provide reasonable protection against harmful interference in a residential installation. This equipment generates, uses and can radiate radio frequency energy and, if not installed and used in accordance with the instructions, may cause harmful interference to radio communications. However, there is no guarantee that interference to radio or television reception, which can be determined by turning the equipment off and on, the user is encouraged to try to correct the interference by one or more of the following measures:

- Reorient or relocate the receiving antenna.
- Increase the separation between the equipment and receiver.
- Connect the equipment into an outlet on a circuit different from that to which the receiver is connected.
- Consult the dealer or an experienced radio/ TV technician for help.

Changes or modifications not expressly approved by the party responsible for compliance could void the user's authority to operate the equipment.

For the receiver devices associated with the operation of a licensed radio service (e.g. FM broadcast), they bear the following statement:

This phone complies with Part 15 of the FCC Rules.

Operation is subject to the following two conditions:

- This device may not cause harmful interference.
- This device must accept any interference received, including interference that may cause undesired operation.

Your phone is equipped with a built-in antenna. For optimal operation, you should avoid touching it or degrading it.

As mobile devices offer a range of functions, they can be used in positions other than against your ear. In such circumstances the device will be compliant with the guidelines when used with a headset or usb data cable.

If you are using another accessory ensure that whatever product is used is free of any metal and that it positions the phone at least 15mm away from the body.

Please note by using the device some of your personal data may be shared with the main device. It is under your responsibility to protect your personal data, and to not share it with any unauthorized devices or third party devices connected to yours. For products with Wi-Fi features, only connect to trusted Wi-Fi networks. Also when using your product as a hotspot (where available), use network security. These precautions will help prevent unauthorized access to your device. Your product can store personal information in various locations including a SIM card, memory card, and built-in memory. Be sure to remove or clear all personal information before you recycle, return, or give away your product. Choose your apps and updates carefully, and install from trusted sources only. Some apps can impact your product's performance and/or have access to private information including account details, call data, location details and network resources.

Note that any data shared with TCL Communication Ltd. is stored in accordance with applicable data protection legislation. For these purposes TCL Communication Ltd. implements and maintains appropriate technical and organizational measures to protect all personal data, for example against unauthorized or unlawful processing and accidental loss or destruction of or damage to such personal data whereby the measures shall provide a level of security that is appropriate regarding

- The technical possibilities available.
- The costs for implementing the measures.
- The risks involved with the processing of the personal data.
- The sensitivity of the personal data processed.

You can access, review, and edit your personal information at any time by logging into your user account, visiting your user profile or by contacting us directly. Should you require us to edit or delete your personal data, we may ask you to provide us with evidence of your identity before we can act on your request.

License.....



microSD Logo is a trademark of SD-3C LLC.



The Bluetooth word mark and logos are owned by the Bluetooth SIG, Inc. and any use of such marks by TCL Communication Ltd. and its affiliates is under licence. Other trademarks and trade names are those of their respective owners.

Alcatel 4051S Bluetooth Declaration ID D043660



The Wi-Fi Logo is a certification mark of the Wi-Fi Alliance.

Hearing Aid Compatibility

FCC Requirements for Hearing Aid Compatibility with Wireless Devices
When wireless devices are used near hearing devices (such as hearing aids and cochlear implants), users may detect a buzzing, humming, or whining noise. Some hearing devices are more immune than others to this interference, and wireless devices also vary in the amount of interference that they generate.

The wireless telephone industry has developed ratings to assist hearing device users in finding wireless devices that may be compatible with their hearing devices. Not all wireless devices have been rated. Wireless devices that are rated will have the rating displayed on the box together with other relevant approval markings.

The ratings are not guarantees. Results will vary depending on the user's hearing device and hearing loss. If your hearing device is vulnerable to interference, you may not be able to use a rated wireless device successfully.

Consulting with your hearing health professional and testing the wireless device with your hearing device is the best way to evaluate it for your personal needs.

This device has been tested and rated for use with hearing aids for some of the wireless technologies that the device uses. However, other wireless technologies may be used in this device that have not been tested for use with hearing aids. It is important to try the different features of your device thoroughly and in different locations to determine if you hear any interfering noise when using this device with your hearing aid or cochlear implant. Consult your wireless service provider about its return and exchange policies, and for information about hearing aid compatibility.

Your 4051S device is M4/T4 compatible. Reference ANSI C63.19- 2011.

How the ratings work

M-Ratings: Wireless devices rated M3 or M4 meet FCC requirements and are likely to generate less interference to hearing devices than wireless devices that are not labeled. M4 is the better or higher of the two ratings.

T-Ratings: Wireless devices rated T3 or T4 meet FCC requirements and are likely to be more usable with a hearing device's telecoil ("T Switch" or "Telephone Switch") than unrated wireless devices. T4 is the better or higher of the two ratings. (Note that not all hearing devices have telecoils in them.)

Hearing devices may also be measured for immunity to this type of interference. Your hearing device manufacturer or hearing health professional may help you find results for your hearing device. The more immune your hearing aid is, the less likely you are to experience interference noise from wireless devices.

For more information about the actions that the FCC has taken with regard to hearing aid compatibility with wireless devices and other steps that the FCC has taken to ensure that individuals with disabilities have access to telecommunications services, visit www.fcc.gov/cgb/dro.

For more information please visit our website us.alcatelmobile.com

You have purchased a product which uses the open source (<http://opensource.org/>) programs mtd, msdosfs, netfilter/iptables and initrd in object code and other open source programs licensed under the GNU General Public Licence and Apache Licence.

You may download the source codes from <http://sourceforge.net/projects/alcatel/files/>. The provision of the source code is free of charge from the internet.

General information

- **Website:** us.alcatelmobile.com
- **Manufacturer:** TCL Communication Ltd.
- **Address:** 5/F, Building 22E, 22 Science Park East Avenue, Hong Kong Science Park, Shatin, NT, Hong Kong
- **Electronic labeling path:** Touch **Settings > About phone > E-Label** to find more information about labeling ⁽¹⁾, such as FCC ID.

Your device is a transceiver that operates on GSM (850/1900), UMTS (B2/4/5) and LTE (B2/4/5/13).

Protection against theft ⁽²⁾

Your device is identified by an IMEI (serial number) shown on the packaging label and in the device's memory. We recommend that you note the number the first time you use your device by dialing *#06# and keep it in a safe place. It may be requested by the police or your service provider if your device is stolen. This number allows your device to be blocked preventing a third person from using it, even with a different SIM card. The IMEI is a unique number used to identify your device.

Disclaimer

There may be certain differences between the user manual description and the device's operation, depending on the software release of your device or specific service providers.

TCL Communication Ltd. shall not be held legally responsible for such differences, if any, nor for their potential consequences, which responsibility shall be borne by the service provider exclusively.

⁽¹⁾ This may vary depending on country.





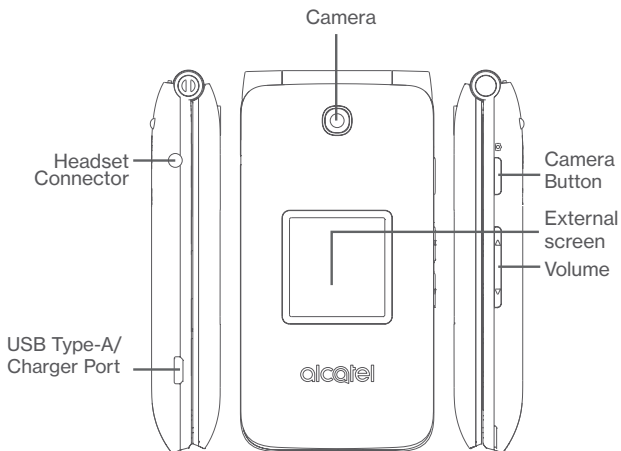

⁽²⁾ Contact your service provider to check service availability.

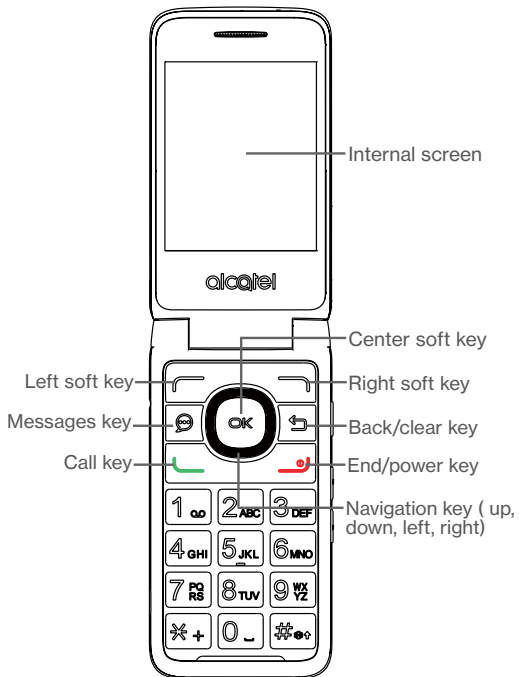

1 Your mobile

1.1 Keys and connectors





| | |
|--|--|
|  | <p><u>Left soft key</u></p> <ul style="list-style-type: none"> • From Home Screen: view notifications • From open applications: create a new event (Calendar) or text (Messaging), take a photo (Gallery), and more |
|  | <p><u>Right soft key</u></p> <ul style="list-style-type: none"> • From Home Screen: view shortcuts to turn on/off Wi-Fi, sound settings, Airplane Mode, and more • From open applications: view options or settings menus |
|  | <p><u>Center soft key</u></p> <ul style="list-style-type: none"> • Access app list (from Home screen) • Confirm an option (press the middle of the key) |
|  | <p><u>Navigation key</u></p> <ul style="list-style-type: none"> • Menu selection moves up, down, right, and left • Different functions may be assigned to each navigation direction |
|  | <p><u>Messages key</u></p> <ul style="list-style-type: none"> • Open messages inbox from any screen |
|  | <p><u>Back/clear key</u></p> <ul style="list-style-type: none"> • Return to the previous screen, options menu or close a dialog box |
|  | <p><u>Call key</u></p> <ul style="list-style-type: none"> • Make a call • Access call log (from App list and Home screen) |

| | |
|--|---|
|  | <p><u>End/power key</u></p> <ul style="list-style-type: none"> • Power on/off the handset (press and hold) • End a call • Return to Home screen (from any app screen) |
|  | <p><u>Camera key</u></p> <p>Press to</p> <ul style="list-style-type: none"> • access Camera app • take a picture or shoot video within Camera mode |
|  | <p><u>Volume Keys</u></p> <p>Press up/down to</p> <ul style="list-style-type: none"> • adjust the volume during a phone call or while listening to media • adjust ringtone volume setting • mute the ringtone of an incoming call |

1.2 Getting started

Your device already has a NANO SIM card installed.

MicroSD cards (up to 32GB) may be purchased separately.

NOTE: Power off the device before opening the back cover to remove and/or insert the NANO SIM or microSD card.

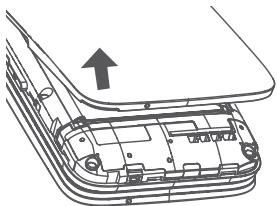

Step 1. With the device facing down, remove the back cover from the bottom left corner. Use your fingernail to carefully lift the cover away from the phone body.

Step 2. Remove the battery using your fingernail to lift from the top right corner.

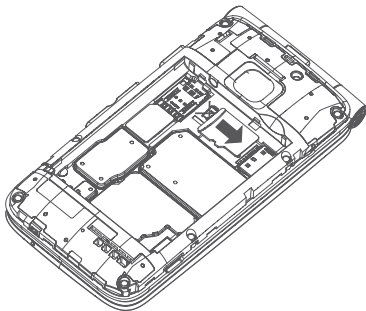

Step 3. To insert microSD card, push the microSD card into the card slot with the gold-colored contacts facing down. To remove the microSD card, push down the plastic tab and slide out the microSD card.

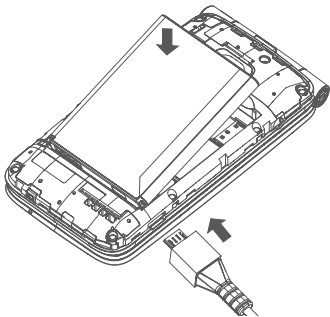

Step 4. Re-install the battery by aligning the gold contact points of the battery with the gold contact points of the device. It only fits one way. Press down to snap in place.

Step 5. Carefully align the back cover with tabs and press into place. It only fits one direction

Step 6. Charge your device by inserting the small end of the charging cable into the charger port as shown, then plug the AC adapter into a wall outlet. Charge your device fully before turning it on and starting the set up process.

Note: Do not conduct the set up process while the device is charging.



To reduce power consumption and energy waste, disconnect your charger when the battery is fully charged, and switch off Wi-Fi, Bluetooth and other wireless connections when they are not in use. In Settings you can also lower the brightness of the screen, and shorten the length of time before the screen goes to sleep.

Power on/off your device

To power on your device, press and hold the **End** key.

To power off your device, press and hold the **End** key, then press the **Center Soft** key to select "**Power off**".

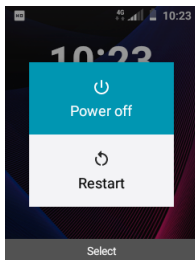

1.3 Home screen

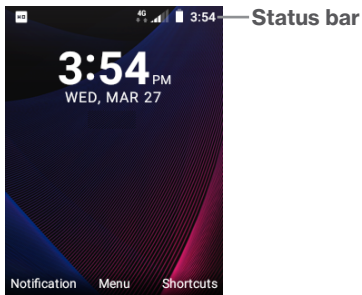

1.3.1 Status Bar

The Status bar appears at the top of your Home screen. Icons indicating your device's status and new notification alerts appear in the Status bar.

1.3.2 Change home screen wallpaper

From the Home screen, press the **Center Soft Key** (OK), select **Settings** icon (gear) and then use the Navigation Keys to scroll until you find **Display > Wallpaper**. Choose between preloaded designs or one you captured with the device. Press the **Center Soft Key** (OK) to save.

1.4 App list

Press the **Center soft** key from the Home screen to access the App list.

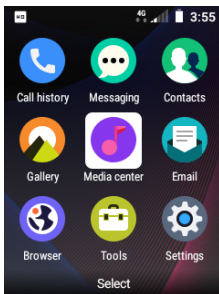

1.5 Inputting text

There are different ways to enter text to create contacts, write emails or send messages.

You may choose from the different methods by pressing the left soft key and alternate between:

- **Kt9**: predictive text mode is a feature that allows you to type faster, as the device tries to predict what you are writing. To type "Hello"

press once the "4" key

press once the "3" key

press once the "5" key

press once the "6" key

As you type, word suggestions will appear at the bottom of the screen. If you see the word you are trying to type, select it with the navigation key and press **OK**.

- **Abc (sentence case), abc (lower case), or ABC (caps lock case):** with this mode you must press each key multiple times to create each letter. For example, an 'S' is created by pressing the '7' key three times. An 'e' is created by pressing '2' twice, and so on.
- **123:** this mode generates only numbers. You may type '1' by pressing the '1' key just once, '2' by pressing '2' and so on. Switch back to ABC, Abc, abc or Kt9 mode to continue writing words.
- **Symbols:** This function provides punctuation and special characters. Symbols may be accessed by pressing the * + key as well. Find the right symbol by pressing right or left on the edges of your center navigation key. When the cursor highlights a symbol you want to add, press the OK key to select it.







2

Calls.....



2.1 Making a call

You may dial a number, call a number from your call history, or call someone in your contacts.

- **Dialing:** From the home screen, dial the number and press the **Call Key**  to place the call. If you make a mistake, you can delete the incorrect digits by pressing the **Back/Clear key** .
- **Call History:** Access your Call History by pressing the **Call Key** . Use the Navigation Keys to view lists of incoming, outgoing, and missed calls. Press the **Call Key**  to place a call to the selected number or contact.
- **Contacts:** Press the **Center Soft Key**  to access the App list. Select **Contacts** and use the Navigation keys to locate the contact, then press the **Call Key** .

Press the **End/Power Key**  to disconnect the call.

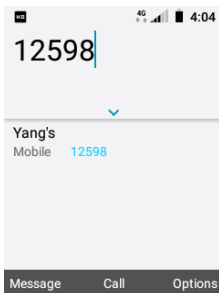

International call

To dial an international call, press ***+** twice to enter “+”, then enter the international country prefix followed by the full phone number and finally press the **Call Key** .

Emergency call

If your device has network coverage, dial emergency number and press the **Call Key**  to make an emergency call. This works even without a SIM card.

2.2 Answer or decline a call







You may choose to answer a call by opening the flip or by pressing any key on the keypad.

To change your phone answer settings, go to **Settings > Call settings > Answer options** and then choose **Flip open** or **Any Key**.

If you have Flip open as your answer option, you can:

- Accept a call by simply opening the device.

If you have Any Key as your answer option you can:

- Accept a call by opening the device and pressing any key (except the **End/Power Key** , **Messaging Key**  or **Right Soft Key** .
- Send the caller a SMS text message by opening the device and pressing the **Left Soft Key** .
- Decline or ignore a call by opening the device and pressing the **End/Power Key**  or the **Right Soft Key**  to decline.

2.3 Calling your voicemail ⁽¹⁾



- Press and hold **1**  to call voicemail.
- Follow the prompts to set up your voicemail account.

⁽¹⁾ Contact your network operator to check service availability.

3 Contacts.....



3.1 View your contacts

Contacts stores contact information you need to quickly and easily access. You can access this function by pressing the **Center Soft Key**  from the Home screen and select **Contacts** app .

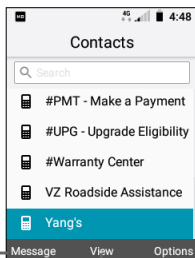

Press the **Left Soft Key**  in the contact list to send a text message.

Press the **Right Soft Key**  to access more options.

Press the **Center Soft Key**  to view contact detail.

3.2 Adding a contact

In contacts list screen, press the **Right Soft Key**  to access **Options**, select **New contact**, and input the contact information.

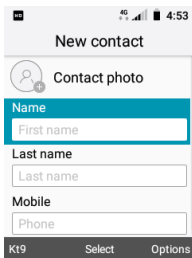

When finished, press the **Right Soft Key**  and then choose **Save**.

3.3 Deleting a contact

In contacts list screen, press the **Right Soft Key**  to view **Options**, select **Delete**, and press the **Center Soft Key**  to delete.

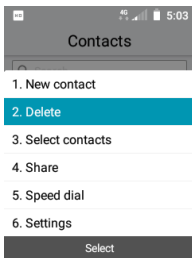





3.4 Editing your contacts

In contacts list, press the up and down of the **Navigation Key** to locate the contact, press the **Center Soft Key**  to **View**, and press the **Center Soft Key**  again to edit.

When finished, press the **Right Soft Key**  and select **Save**.

3.5 Select contacts

Select contacts allows you to quickly delete or share multiple contacts.

- In contacts list screen, press the **Right Soft Key**  to view **Options** and then choose **Select contacts**.
- Use the **Navigation Key** to locate contacts and press the **Center Soft Key**  to select one at a time or the **Left Soft Key**  to select all.
- Press the **Right Soft Key**  to access **Options** and then choose **Delete** or **Share**.

3.6 Sharing your contacts

You can share a single contact with others by sending the contact's vCard to them via email, messages, or Bluetooth.

Select a contact you want to share, press the **Right Soft Key**  to view **Options**, and then select **Share**.

3.7 Speed Dial

Speed dial enables you to assign a phone number or contact to a single digit number (2-9) to quickly make a call by pressing and holding that single number on the keypad.

From Contacts list, set speed dial contacts by pressing the **Right Soft Key**  to access **Options**, and then select **Speed Dial**.

3.8 Available options

From the contact list, you can access the following options:

Call

Make a call to the selected contact.

Send message

Send an SMS/MMS message to the selected contact.

Settings

Sort contacts by first or last name.

4



Messages.....





Use the messaging feature to send and receive text (SMS) and multimedia (MMS) messages.

4.1 Write message

From the Home screen, press the **Center Soft Key**  and select Messages icon  or press the **Message Key**  directly from idle screen to enter Messages.

Press the **Left Soft Key**  to create a new message, or press the **Center Soft Key**  to view a current message thread.

- Enter the phone number of the recipient in the To bar or press the **Right Soft Key**  to add recipients.
- Use the Navigation Keys to select the Message bar and enter the text of the message.
- Press the **Left Soft Key**  or **pound sign #** to switch input method: **Kt9** (predictive word mode), **abc** (lowercase), **Abc** (sentence case), **ABC** (caps lock), **123** (numeric), or **Symbols** (punctuation and special characters). More information on text input methods is available in section “1.5 Inputting text”
- Press the **Center Soft Key**  to send the message.

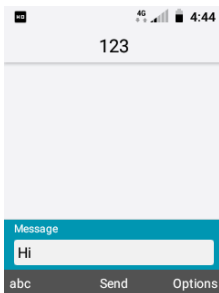

4.2 Send a multimedia message

MMS enables you to send video clips, images, photos, contacts and sounds to other compatible devices and email addresses.

Within a message thread, press the **Right Soft Key**  to add an attachment, such as a photo, video, audio clip or contact.

An SMS will be converted to MMS automatically when media files are attached or email addresses added.

4.3 Settings

The messages settings menu lets you control options for your text and MMS messages including message limits, size settings, and notifications.

On the Messages screen, press the **Right Soft Key**  to access **Settings**. You can set the following:

- **Notifications tone** Press to select notification tone.
- **Vibrate** Press to enter vibrate options.
- **Auto signature** Press to enter signature contents.
- **Delete old message** Enable old messages to be automatically deleted when limits are reached.
- **Conversation message limit** Press to set message limit within a conversation thread. The default limit is 1000 messages.
- **Send read receipts** Enable automatic response to read receipt requests for each message you receive.
- **Request receipt** Enable delivery receipts and read receipts for each message you send.
- **Auto-retrieve** Enable messages to be automatically retrieved.
- **Roaming auto-retrieve** Enable messages to be automatically retrieved while roaming.



5

Email



You can access the Email App by pressing the **Center Soft Key**  from the Home screen and selecting **Email**.





Several options for email providers will be listed on the screen.

- Locate your email provider using the Navigation Keys, select using the **Center Soft Key** , and enter your login information for the account.
- Press the **Right Soft Key**  to continue.

You may also select Manual setup. Follow the prompts on the screen to enter the necessary information, using the Navigation Keys to scroll between options and the **Center Soft Key**  to select. If your email provider is not listed, select **Other** from the email providers screen to enter **Manual setup**.

To add another email account, you can press the **Right Soft Key**  to access **Options/ Settings**. And then select **Add account**.

To create and send emails

- Press the **Left Soft Key**  to compose a new email from the Inbox screen.
- Enter recipient(s) email address(es) in the To field.
- If necessary, press the **Right Soft Key**  to add Cc/Bcc or add attachment to the message.
- Enter the subject and the content of the message.
- If you do not want to send the mail right away, you can press the **Right Soft Key**  and select **Save as draft** or touch the **Back key**  to save a copy.
- Press the **Left Soft Key**  to send.

6 Media center.....



Use Media Center to play music files stored in your device. Music files can be downloaded from your computer to device using a USB cable.

To access the **Media center** app, press the **Center Soft Key**  from the Home screen and select **Media center**.

7

Browser.....



Enjoy surfing the web using Browser. Save your most frequently visited sites using the bookmark function.

To access the **Browser** app, press the **Center Soft Key**  from the Home screen and select **Browser**.

8



Tools.....



8.1 Recorder

To access this function, press the **Center Soft Key**  from the Home screen, select the **Tools** app and select **Recorder**.

Recorder allows you to record voice/sound in an hour: minute: second format.

- Press the **Center Soft Key**  to start recording.
- Press the **Center Soft Key**  again to stop.
- Press the **Left Soft Key**  to pause, and press again to resume.

When you select "stop" the recording will automatically save and return you to the Recordings Storage screen. Use the Navigation Keys to locate a recording, and press the **Center Soft Key**  to play the recording.

8.2 Calendar

To access this function, press the **Center Soft Key**  from the Home screen, select the **Tools** app and select **Calendar**.

Use the Calendar to keep track of important meetings, appointments and more.

8.2.1 Multimode view

You can display the Calendar in Day, Weekly, Monthly view. Press the **Right Soft Key**  to change your Calendar view.

8.2.2 To create new events

Press the **Left Soft Key**  to add new events from any Calendar view.

- Fill in all required information for this new event. Select **All-day Event** if applicable.

- When finished, press the **Center Soft Key**  to save.

Additional options are available by pressing the **Right Soft Key**  from the Calendar main screen:

- **Go to date** Enter a specific date you want to view.
- **Search** Search for an event you added in Calendar.
- **Calendar to display** Display a specific calendar, such as an imported one.
- **Settings** To set a series of Calendar settings.

8.2.3 Event reminder

If a reminder is set for an event, the upcoming event icon  will appear on the Status bar as a notification when the reminder time arrives.

8.3 Clock

Your mobile device has a built-in clock.

To access this function, press the **Center Soft Key**  from the Home screen, select the **Tools** app and select **Clock**.

8.3.1 World clock

The system will set a default clock determined by your service provider and network.

Press the **Left Soft Key**  add a location or time zone to add to the World clock feature.

8.3.2 Alarm

To set an alarm

Use the Navigation Keys to access the Alarm screen within the Clock function. Press the **Left Soft Key**  to add a new alarm. The following options will appear:

- **Time** Press to set the alarm time.
- **Repeat** Select the days you want your alarm to go off.
- **Ringtone** Select a ringtone for the alarm.
- **Vibrate** Press to activate vibration.
- **Alarm title** Press to enter a name for the alarm.





To adjust alarm settings



Additional options are available by pressing the **Right Soft Key**  from the Clock screen:

- **Turn on/off** Press to turn on or turn off the alarm.
- **Edit** Press to edit alarm.
- **Delete** Press to delete alarm.
- **Settings** Press to set snooze time, volume, vibration and sound.

8.3.3 Timer





Use the Navigation Keys to access the Timer screen within the Clock function.

- Press the **Left Soft Key**  to edit hour, minute and second, when finished, press the **Center Soft Key**  again to start timer.
- Press the **Center Soft Key**  to pause timer.
- Press the **Center Soft Key**  again to resume.

- Press the **Right Soft Key**  when timer starts to add 1 minute.
- Press the **Left Soft Key**  to reset the timer on halt screen.

8.3.4 Stopwatch

Use the Navigation Keys to access the Stopwatch screen within the Clock function.

- Press the **Center Soft Key**  to start stopwatch.
- Press the **Center Soft Key**  to pause.
- Press the **Center Soft Key**  again to resume.
- Press the **Left Soft Key**  to reset the stopwatch on halt screen.

8.4 Note

Like a notepad, Note stores inspirations, ideas, excerpts, lists, and much more on your device for future reference.

To access Note, press the **Center Soft Key**  from the Home screen, select the **Tools** app, and select **Note**.

Notes can be shared via Bluetooth, message or email.

8.5 Calculator

To access this function, press the **Center Soft Key**  from the Home screen, select the **Tools** app and select **Calculator**.

Use Calculator to quickly solve simple mathematical problems.

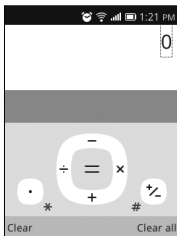

- Use the Navigation Keys to enter arithmetic operations: up for subtract, right for multiply, down for add, and left for divide.
- Use the dial pad to enter numbers, the star sign to enter a decimal, and the pound sign to change a number to positive or negative.
- Select the Center Soft Key  for equals.

8.6 File manager

To access **File Manager**, press the **Center Soft Key**  from the Home screen, select the **Tools** app and select **File Manager**.

File Manager displays all data stored on the device and the microSD card, including data from applications, media files downloaded and created, other data shared via Bluetooth or USB cable, and more.

When you download an application from PC to device/microSD card, you can locate the application using File Manager, then touch it to install it in your device.

File Manager allows you to efficiently perform with the following common operations: create (sub) folder, open folder/file, view, rename, move, copy, delete, play, share, and more.

8.7 Camera

Your mobile device is fitted with a camera for taking photos and shooting videos.

8.7.1 Camera



To access the **Camera** App, press the **Center Soft Key**  from the Home screen, select the **Tools** app and select **Camera**. Camera is also accessible by pressing on the Camera Key on the right side of the device.

To take a picture



The screen acts as the viewfinder. Position the object or landscape in the viewfinder, and press the **Center Soft Key**  or **Camera Key** on the right side of the device to take the picture which will be automatically saved to your gallery.

Before taking a picture, you can adjust a number of settings.

Zoom in/out Viewfinder

- Press * in the keypad to zoom in and press # in the keypad to zoom out the viewfinder.
- Press the **Right Soft Key**  to access **Video**:
- Press the **Left Soft Key**  to access **Gallery**.

To shoot a video





- Press the **Right Soft Key**  to switch to Video mode from Camera mode.
- Press the **Center Soft Key**  or **Camera Key** to shoot a video.
- When complete, press the **Center Soft Key**  or **Camera Key** again to save. Videos will be saved to your gallery.

8.7.2 Gallery

Gallery acts as a library for you to view, edit, share, or delete photos and videos.

To access this function, press the **Left Soft Key**  to switch to Gallery from Camera mode. Gallery is also accessible by pressing the **Center Soft Key**  from the Home screen, and selecting the Gallery app.

Within the Gallery App:

- Press the **Left Soft Key**  to return to the Camera App.
- Press the **Center Soft Key**  to view a photo or video.
- Press the **Right Soft Key**  to view options for the selected photo or video which allows you to:
 - **Delete** Delete the selected picture.
 - **Share** Share the picture via Email, messages or Bluetooth.
 - **Edit** Select this option to adjust exposure value, rotate the picture, crop, add filters or auto-correction.
 - **Set as wallpaper** Set the selected picture as wallpaper.
 - **Set as contact photo** Assign the selected picture to a contact.
 - **View full screen** Press the **Center Soft Key**  to view the selected photo in full screen.
 - **Info** View the picture information, such as title, file size, image type, time stamp and resolution.

9

Settings.....



To access **Settings**, press the **Center Soft Key** (OK) from the Home screen and select **Settings**.

9.1 My Verizon

Provides service provider plan detail, usage information, and support information.

9.2 Wireless & Networks

9.2.1 Airplane Mode

When Airplane mode is on, it will simultaneously disable all wireless connections including Wi-Fi, Bluetooth and more.

9.2.2 Wi-Fi

Provides a list of available Wi-Fi networks to connect to. Select a network using the up and down navigation keys, and press the **Center Soft Key** (OK) to connect. If required, enter the network password. To disconnect from a network, press the **Left Soft Key** (Left Arrow) while selecting the network.

9.2.3 Bluetooth

Bluetooth allows your device to exchange data (videos, images, music) within a small range with another Bluetooth supported device (device, computer, printer, headset, car kit).

Using the up and down navigation keys, select from available devices to connect to by pressing the **Center Soft Key** (OK) (make sure the device you want to connect to is powered on and ready to pair). Select the **Left Soft Key** (Left Arrow) to unpair with a device.

9.2.4 Tethering & Mobile hotspot

USB tethering

You can share your device's mobile data connection with a single computer via a USB cable.

Bluetooth tethering

You can share your device's mobile data connection via Bluetooth.

When this is selected on, your device will appear visible to other devices.

Mobile Hotspot

Press the **Left Soft Key**  to turn-on Mobile Hotspot. Follow the instructions on screen to connect another device to the hotspot connection. Up to 10 devices may be supported.

To customize the network and password press the **Right Soft Key**  for Options and select Set Up Mobile Hotspot.

9.2.5 VPN

Virtual private networks (VPNs) allow you to connect to the resources inside a secured local network from outside that network. VPNs are commonly deployed by corporations, schools, and other institutions so that their users can access local network resources when not inside that network, or when connected to a wireless network.

9.2.6 Mobile networks

Mobile data

If you do not need to transmit data on all mobile networks, turn off Mobile data to avoid incurring significant charges for data use on local operator mobile networks, particularly if you do not have a mobile data agreement.

Data usage

Press to review data usage information.

Data roaming access

If you don't need to transmit data on other operators' mobile networks, turn off **Data roaming access** to avoid incurring significant roaming charges.

Network operators

You can select a network operator.

Network type and strength

Press the **Center Soft Key**  to review network type and strength.

Access Point Name

Select your preferred network with this menu.

Roaming state

Press to view roaming state.

Preferred network mode

You can set your preferred network mode, such as LTE/UMTS/GSM or LTE only.

9.2.7 Emergency Alerts

To access your Emergency Alerts settings, go to **Settings > Wireless & Networks > Emergency Alerts**. Press the **Right Soft Key**  to enter a menu which allows enabling and disabling of the following alerts:

- Extreme alerts
- Severe alerts
- Amber alerts

Vibrate

Emergency alerts will notify you by vibrating your device.

Audio

Emergency alerts will notify you by an audio tone.

Alert reminder

Set repeat reminders for Emergency Alerts to alert you once, every 2 minutes, or every 5 minutes.

Text to speech

Enable text to speech for Emergency Alerts so alerts are read aloud.

9.3 Accessibility

Readout

Readout mode is a text-to-speech function which reads labels of interface elements aloud. You may adjust the speech rate, volume, create an off/on shortcut, and more within this menu.

Large text

Enable large text to enlarge the screen text.

Color inversion

Turn on/off color inversion to invert the screen colors and increase text contrast.

Color correction

Turn on/off Protanomaly (red-green), Deuteranomaly (red-green) or Tritanomaly (blue-yellow). color correction.

Captions

Turn on/off screen captions. Text size and language options may be found within this menu.

Mono Audio

Turn on/off mono audio.

Hearing aid

Hearing aid mode can be used by people who are deaf, have poor hearing or speech impairments. After connecting the device and hearing aid device, calls are linked to a relay service, which converts incoming speech to text for the person using the hearing aid and converts outgoing text from the hearing aid device to a spoken voice for the person on the other end of the conversation.

TTY mode

TTY mode can be used by people who are deaf, have poor hearing or speech impairments.

Turn on/off TTY to full, VCO, or HCO.

RTT visibility

Press to set RTT(Real Time Texting) visibility when placing calls or only during calls.

9.4 Sound & notifications

Volume

This menu will allow you to set the volume for Alert sounds and Media.

Sound with vibration

Turn on/off vibration.

Ringtones

This menu will allow you to select ringtones.

Notification sounds

This menu will allow you to choose notification sounds.

Keypad sound

Turn on/off sound when pressing buttons and keys.

9.5 Display

Menu layout

Choose whether to list your applications within the Menu as a grid or list.

Wallpaper

This menu will allow you to select wallpaper from the wallpaper gallery, or from your captured photos in your gallery.

Brightness

Set the level of screen brightness.

Display backlight

This menu will allow you to set how long the screen will stay lit before turning off.

Key backlight

This menu will allow you to select how long the buttons and keys will stay backlit before turning off.

Font size

This menu will allow you to set font size.

9.6 Phone settings

Language

This menu will allow you to change the default language.

Key shortcuts

This menu will allow you to assign shortcuts to the Navigation Keys when pressed on the Home screen.

Storage

Press to view device storage information.

Location

Turn on/off location services, which allows the device's location to be recognized.

Security

- **Screen lock** Turn on/off screen lock. This requires you to set a PIN, which will be need to be entered to unlock the device.
- **Encrypt phone** Encrypt your device requires screen lock first. You'll need to unlock the screen to decrypt the device every time you power it on.
- **Certificate manage** Press to view trusted credentials or install credentials from storage.
- **SIM card lock** Turn on/off SIM card lock.

Accounts

Set up a Verizon Cloud account which will keep your contacts and data backed up and stored within Verizon's cloud.

Reset

- **Factory data reset** Choose to reset data on phone, SD card, or phone and SD card
- **Reset settings** If any system settings were changed, reset settings can return the device to its original behavior.
- **Last factory data reset** Press to review last factory data reset information.

Data & time

- **Auto-date & time** Allows your device to automatically sync the date and time with the service provider.
- **Set date** You must turn off Auto-date & time to be able to set the device's date manually.
- **Set time** You must turn off Auto-date & time to be able to set the device's date manually.
- **Auto-time zone** Allows your device to automatically sync the time zone with the service provider.
- **Select time zone** You must turn off Auto-time zone to be able to set the device's time zone manually.
- **Time format** Select 12-hour clock format or 24-hour clock format.

9.7 Call settings

Activate Wi-Fi calling

Turn on/off Wi-Fi calling to allow your device to make calls over a Wi-Fi network.

Answer options

Choose to press a key to answer or flip open the device to answer.

Ignore with Message

Enable the option to reject an incoming call and send a text message to the caller.

Speed dial

View your list of speed dial contacts. For more information on speed dial, please view “3.7 Speed Dial”.

Voice mail

Choose the notification type for when your voice mail has a new message. Voice mail works like an answering machine for missed or ignored calls.

To access your voice mail, press and hold  from dial screen.

If you receive a message, a voice mail icon appears on the Status bar.

Assisted dialing

Enable assisted dialing.

Blocked calls

View phone numbers you've blocked or blacklisted, or add a phone number to the list.

Auto redial

Set auto redial time.

Call Forwarding

Configure how your calls are forwarded when you are busy or unreachable.

Call duration

View call duration information.

9.8 About phone

Provide device information such as your phone number, IMEI, IMS registration status, ICCID, Network, Battery, Hardware, Software information, Legal info, E-label, and Build number.

9.9 Software update

Update your device's software by checking for new updates. If an update is available and you want to update the system, select Download. When the download is complete, select Install to complete the upgrade. Now your device's software will be the latest version.

You are recommended to have the device connected to Wi-Fi to avoid data connection fees, and to enable auto-update. Settings for auto-update are available once you restart the device.

With auto-update enabled, a dialog box will appear on the screen to download a new version. A notification will also show in the status bar. You may choose to ignore, postpone or initiate the update.

10 Accessories

Standard accessories:

1. AC Charger
2. Lithium-ion battery
3. Quick Start Guide & warranty information
4. Product Safety Information
5. Pre-installed NANO SIM card



Only use the Alcatel batteries, chargers, and accessories included along with your device.

11 1 Year Limited Warranty.....

TCT Mobile Inc., offers a 1 year limited warranty on all TCL, Alcatel, Alcatel One Touch, BlackBerry devices that are found to be defective in materials or workmanship upon submission of the following items:

1. Proof of purchase – consisting of original invoice or sales slip indicating the date of purchase, dealer's name, model and serial number of the product.

General Terms and Conditions

This warranty is confined to the first purchaser of the product only and is not applicable to cases other than defects in material, design and workmanship.

Items and Conditions Not Covered:

- Damages resulting from normal wear and tear and/or the need for regular maintenance shall not constitute a defect under the terms of this warranty.
- Abuse or misuses, including but not solely limited to the failure to use this product for its normal purposes or in accordance with TCT's instructions on usage and maintenance.
- Defects resulting from usage of the product in conjunction with accessories that are not approved by TCT for use with this product.
- TCT will not be responsible for any repairs caused by third party component parts, or service that is found to be the cause for the defect or damage of the product.
- TCT will not be responsible for failure to use the battery in accordance with the specific instructions of core outlined in the product user manual. For example, do not attempt to open sealed devices, such as batteries. Opening of sealed devices may result in bodily injury and/or property damage.
- Accidents, Acts of God, lightning, water, fire, public disturbances, improper ventilation, voltage fluctuations or any cause beyond the control of TCT.

- This warranty does not affect the consumers' statutory rights nor the consumers' rights against the dealer related to their purchase/ sales agreement.

TCT's 1 Year Limited Warranty will abide by the following options regarding claims:

1. Repair the TCT product using new or previously used parts that are equivalent to new in performance and reliability.
2. Replace the TCT product with the same model (or with customer consent a product that has similar functionality) formed from new and/ or previously used parts that are equivalent to new in performance and reliability.
 - a. When a TCT product or part is replaced or provided, any replacement item becomes the customer's property and the replaced or refunded item becomes TCT's property.
 - b. TCT will not provide any data transfer service. This is the customer's responsibility. TCT shall not be liable for the loss of any saved/stored data in products that are either repaired or replaced. Customer should maintain a separate backup copy of the contents of the device's data.
3. All refund requests shall be submitted to the retailer where the device(s) were originally purchased and shall subject to the retailer's refund policies. Customers may obtain the retailers return policies at the links provided below:
 - a. U.S. <https://us.alcatelmobile.com/return-policy/>
 - b. Canada <https://ca.alcatelmobile.com/return-policy/>
4. Repair or Replacement of any TCT product under the terms of this warranty does not provide right to extension or renewal of the warranty period.
5. Warranty repairs are available free of charge at TCT authorized repair centers for products that comply with the General Terms and Conditions of this warranty. Shipping cost of the defective product(s) to TCT authorized repair center is to be paid by the customer. The customer is responsible for any damage to the defective product during shipment to the authorized repair center.

6. This warranty is not transferrable. This warranty will be the purchasers' sole and exclusive remedy and neither TCT nor its service centers shall be liable for any incidental or consequential damages or breach of any express or implied warranty of this product.

7. This warranty extends to products purchased and sold within the United States and Canada. All products sold in United States will be subject to their respective state and federal laws. All products purchased in Canada will be subject to Canadian laws.

Company Contact Information

Customer Care may be contacted at:

USA Phone Number 855-368-0829 or <https://us.alcatelmobile.com/>

Canada Phone Number 855-844-6058 or <https://ca.alcatelmobile.com/>

BlackBerry Support # 1 855-223-4034 (USA and Canada) or www.blackberrymobile.com

12 Troubleshooting

Before contacting the service center, you are advised to follow the instructions below:

- You are advised to fully charge () the battery for optimal operation.
- Avoid storing large amounts of data in your device as this may affect its performance.
- Use the FOTA (Firmware Over The Air) Upgrade tool to update your device's software. To access **Software Update**, press **Settings\Software Update**.

and carry out the following checks:

My device can't be switched on or is frozen

- Check the battery contacts, remove and reinstall your battery, then turn your device on.
- Check the battery power level, charge for at least 20 minutes.

My device has not responded for several minutes

- Restart your device by pressing and holding the **End/power** key.
- Remove the battery and re-insert it, then restart the device.

My device turns off by itself

- Check whether your device is locked when not in use, and make sure you don't accidentally turn off your device when locking it by pressing the **End/power** key.
- Check the battery charge level.

My device can't charge properly

- Make sure you are using an Alcatel battery and the charger from the box.
- Make sure your battery is inserted properly and clean the battery contact if it's dirty. It must be inserted before plugging in the charger.

- Make sure that your battery is not completely discharged. If battery power is empty for a long time, it may take around 20 minutes to display the battery charger indicator on the screen.
- Make sure charging is carried out under normal conditions (0°C to +45°C).
- When abroad, check that the voltage input is compatible.

My device can't connect to a network or "No service" is displayed

- Try connecting in another location.
- Verify the network coverage with your carrier.
- Check with your carrier that your SIM card is valid.
- Try selecting the available network(s) manually.
- Try connecting at a later time if the network is overloaded.

My device can't connect to the Internet

- Check that the IMEI number (press *#06#) is the same as the one printed on your warranty card or box.
- Make sure that the internet access service of your SIM card is available.
- Check your device's Internet connecting settings.
- Make sure you are in a place with network coverage.
- Try connecting at a later time or another location.

Invalid SIM card

- Make sure the SIM card has been correctly inserted.
- Make sure the chip on your SIM card is not damaged or scratched.
- Make sure the service of your SIM card is available.

Unable to make outgoing calls

- Make sure you have dialed a valid number and have pressed .
- For international calls, check the country and area codes.
- Make sure your device is connected to a network, and the network is not overloaded or unavailable.

- Check your subscription status with your carrier (credit, SIM card valid, etc.).
- Make sure you have not barred outgoing calls.
- Make sure that your device is not in Airplane mode.

Unable to receive incoming calls

- Make sure your device is switched on and connected to a network (check for overloaded or unavailable network).
- Check your subscription status with your carrier (credit, SIM card valid, etc.).
- Make sure you have not forwarded incoming calls.
- Make sure that you have not barred certain calls.
- Make sure that your device is not in Airplane mode.

The caller's name/number does not appear when a call is received

- Check that you have subscribed to this service with your carrier.
- Your caller has concealed his/her name or number.

I can't find my contacts

- Make sure your SIM card is not broken.
- Make sure your SIM card is inserted properly.
- Import all contacts stored in SIM card to device.

The sound quality of the calls is poor

- You can adjust the volume during a call by pressing the **Volume Up/down** key.
- Check the network strength .
- Make sure that the receiver, connector or speaker on your device is clean.

I am unable to use the features described in the manual

- Check with your carrier to make sure that your subscription includes this service.
- Make sure this feature does not require an Alcatel accessory.

When I select a number from my contacts, the number can't be dialed

- Make sure that you have correctly recorded the number in your file.
- Make sure that you have selected the country prefix when calling a foreign country.

I am unable to add a contact in my contacts

- Make sure that your SIM card contacts are not full. Delete some files or save the files in the device contacts.

My callers are unable to leave messages on my voicemail

- Contact your network carrier to check service availability.

I can't access my voicemail

- Make sure your carrier's voicemail number is correctly entered.
- Try later if the network is busy.

I am unable to send and receive MMS

- Check your device memory availability as it might be full.
- Contact your network operator to check service availability and check MMS parameters.
- Verify the server center number or your MMS profile with your carrier.
- The server center may be swamped, try again later.

SIM card PIN locked

- Contact your network carrier to obtain the PUK code (Personal Unblocking Key).

The device can't be detected by others via Bluetooth

- Make sure that Bluetooth is turned on and your device is visible to other users.
- Make sure that the two devices are within Bluetooth's detection range.

13 Specifications

| | |
|-------------------------|---|
| Processor | Qualcomm Snapdragon™ 210, MSM8909 |
| OS | Alcatel Proprietary OS |
| Memory | 8 GB ROM + 1 GB RAM |
| Dimensions (LxWxD) | 105 x 52.8 x 18.7mm |
| Weight | 118g with battery |
| Display | External Display: 1.44-inch TFT LCD Internal Display: 2.8-inch TN LCD |
| Network | GSM: 850/1900 MHz UMTS: B2/4/5 LTE: B2/4/5/13 (Band frequency and data speed are carrier dependent.) |
| GPS | A-GPS |
| Connectivity | <ul style="list-style-type: none">• Bluetooth 4.2• Wi-Fi 802.11b/g/n• 3.5mm audio jack• Micro-USB type A |
| Camera | <ul style="list-style-type: none">• 2MP |
| Audio supported formats | AAC LC, AAC+, eAAC+, AMR-NB, AMR-WB, FLAC, MIDI, MP3, WAV, Vorbis |

| | |
|------------------------|---|
| Battery ⁽¹⁾ | 1350mAh Lithium-ion (removable) |
| Expansion Slot | microSD™ memory card (sold separately) |
| Special Features | <ul style="list-style-type: none"> • Mobile Hotspot (up to 10 devices) • WEA Enabled • HAC M4/T4 • TTY/TDD Enabled • RTT (Real time Texting) |

Note: Specifications are subject to change without prior notice.

⁽¹⁾ The original battery has undergone rigorous safety inspections to meet qualification standards, the use of non-original batteries may be dangerous.

Life **IS CALLING.**
TAKE IT WITH YOU.

CHARITYMOBILE.COM

1-877-474-3662